

VisionAire™

Oxygen Concentrator Service Manual

For VisionAire, VisionAire 2 & VisionAire 3 Models



AirSep Corporation · 401 Creekside Drive · Buffalo, NY 14228-2085 USA
Telephone: (716) 691-0202 · 24-Hour Fax: (716) 691-4141 · www.airsep.com

Expedited Product Warranty Check service is always at your fingertips with AirSep:

<http://www.airsep.com/medical/equipmentproviders.html>

OR

In the US or Canada,
dial **866-873-9277**

AirSep® is a registered trademark of AirSep Corporation.

•

VisionAire™ is a trademark of AirSep Corporation.

Table of Contents

Section 1.0

Introduction

1.1	Equipment Provider Responsibility	1
1.2	Important Notice and Symbol Explanations	2
1.3	Functional Specifications	5

Section 2.0

Operation Check and Oxygen Concentration Test

2.1	Description of Operation	6
2.2	Operation Check	6
2.3	Alarm System	6
	2.3.1 Start Up	7
	2.3.2 Power Failure Alarm Test	7
	2.3.3 No Flow Alarm Test	7
2.4	Oxygen Concentration Test and Specification	7

Section 3.0

General Instructions

3.1	Instructions	8
3.2	Patient, Provider, and Routine Maintenance	9
	3.2.1 Product Filter – No Maintenance Required	9
	3.2.2 Preparing for New Patient Use/Method of Cleaning and Infection Control	9

Section 4.0

Main Components

4.1	Components	10
4.2	Cabinet Removal	10
	4.2.1 Removing Front Panel	10
	4.2.2 Removing Back Panel	10
4.3	Compressor	10
	4.3.1 Compressor Replacement	11

4.3.2	Capacitor Replacement	12
4.4	Solenoid Valves	12
4.4.1	Valve Manifold Replacement	12
4.4.2	Solenoid Valve Coil Replacement	14
4.5	Sieve Beds	14
4.5.1	Sieve Bed Replacement	14
4.6	Cabinet Fan	15
4.6.1	Cabinet Fan Replacement	15
4.7	Circuit Board	16
4.7.1	Circuit Board Replacement	17
4.8	Product Regulator Check and Setting	18
4.8.1	Setting Product regulator for Normal Operation	18
4.8.2	Product Regulator Lockout	18
4.8.3	Back Pressure Correction	19
4.8.4	Product Regulator Cleaning or Rebuilding	19
4.9	Circuit Breaker Replacement	20
4.10	I/O Power Switch Replacement	20
4.11	Hour Meter Replacement	21
4.12	Flow Meter Replacement	21
4.13	Power Cord Replacement	22
4.14	Oxygen Monitor Circuit Board Replacement	23
4.15	Mixing Tank Replacement	23
4.16	Exhaust Muffler Replacement	23
4.17	Caster Replacement	24
4.18	Roller Base Replacement	25
4.19	Air Outlet Option (if equipped)	25

Section 5.0

Troubleshooting

5.1	Operation Pressure Test	26
	5.1.1 High Operating Pressure	26
	5.1.2 Low Operating Pressure	26
5.2	General Troubleshooting	27
5.3	Troubleshooting Chart	28
5.4	Tool Kit and Pressure Test Gauge	31

Appendix

Exploded Drawings

Wiring Diagram - VisionAire	A
Wiring Diagram – VisionAire 2, VisionAire 3	B
Valve Wire Harness – WH105-1	C
Main Assembly	D
Center Section Assembly	E
Compressor Enclosure Assembly	F
Compressor Assembly	G
Valve Manifold Assembly	H

1.0 Introduction

1.1 Equipment Provider Responsibility

All Equipment Providers of the VisionAire™ Oxygen Concentrator must assume responsibilities for handling, operational check-out, patient instruction, and oxygen concentration checks. These responsibilities are outlined below and throughout this manual.

As an Equipment Provider, you must do all of the following:

- Inspect the condition of each VisionAire unit immediately upon delivery to your business location. Note any sign of damage on the delivery receipt, and report it directly to both the freight company and AirSep Corporation immediately.
- Check the operation of each VisionAire unit before delivery to a patient. Confirm the oxygen concentration level is within specifications as referred to in Section 2.4. (Test the power disconnect alarm as described in Section 2.3 of this manual.)
- Deliver VisionAire units only to patients authorized by a licensed health care provider or physician's prescription. The VisionAire oxygen concentrator must not be used as a life-supporting device. A backup supply of oxygen must be available.
- Instruct patients how to use VisionAire in conjunction with the Patient Manual.
- Instruct patients to notify their licensed health care provider/physician if they experience any signs of discomfort.
- Be available to provide service to each patient at any time.
- Establish and implement a protocol to check oxygen concentration.



This unit is not a life-support device. Geriatric, pediatric, or any other patient unable to communicate discomfort while using this oxygen concentrator may require additional monitoring. Patients with hearing and/or sight impairments may need assistance with monitoring the alarms.





This device supplies high-concentration oxygen that promotes rapid burning. Do not allow smoking or open flames within the same room of (1) this device, or (2) any oxygen-carrying accessory. Failure to observe this warning can result in severe fire, property damage, and/or cause physical injury or death.



Use no oil, grease, or petroleum-based or other flammable products on or near nasal end of cannula or on the VisionAire unit. Oxygen accelerates the combustion of flammable substances.

1.2 Important Notice and Symbol Explanations













As you read the manual, pay special attention to the WARNING, CAUTION, and NOTE messages. They identify safety guidelines or other important information as follows:











	Describes a hazard or unsafe practice that can result in severe bodily injury or death.
	Describes a hazard or unsafe practice that can result in minor bodily injury or property damage.
	Provides information important enough to emphasize or repeat.

Symbols/Abbreviations

Symbols are frequently used on equipment in preference to words with the intention of lessening any possibility of misunderstanding caused by language differences. Symbols can also permit easier comprehension of a concept within a restricted space.

The following table is a list of symbols and definitions that may be used with AirSep's VisionAire Oxygen Concentrators. These symbols are referenced from the appropriate International Electro-technical Commission (IEC) standards:

Symbol	Description	Symbol	Description
	<i>ON (power switch on)</i>		<i>OFF (power switch off)</i>
	<i>No smoking</i>		<i>Do not disassemble</i>
	<i>Type B equipment</i>		<i>Consult instructions for use</i>
	<i>Warning – Describes a hazard or unsafe practice that if not avoided can result in severe bodily injury, death or property damage</i>		<i>Class II Device</i>
	<i>Caution – Describes a hazard or unsafe practice that if not avoided can result in minor bodily injury or property damage</i>		<i>Complies with the 93/42/EEC directive drawn up by the approved organization No. 0459</i>
	<i>Note – Provides information important enough to emphasize or repeat</i>		<i>Safety agency for CAN/CSA C22.2 No. 601.1 M90 for medical electrical equipment</i>

Symbol	Description	Symbol	Description
	<i>Consult the accompanying documents</i>		<i>Keep unit and accessories dry</i>
	<i>Use no oil or grease</i>		<i>Proper disposal of waste of electrical and electronic equipment required</i>
	<i>Oxygen outlet connection to the cannula</i>		<i>Do not expose to open flames</i>
	<i>Caution: Federal law (USA) restricts this for sale or rental by or on the order of a physician or licensed health care provider.</i>		<i>Keep in the vertical position</i>
	<i>Fragile – handle with care</i>		<i>Oxygen concentration warning LED</i>
			<i>See Instructions</i>

Method disposing of waste: All waste from the VisionAire (patient circuit, etc.) must be disposed of using appropriate methods.

Method for disposing of the device: In order to preserve the environment, the concentrator must only be disposed of using the appropriate methods.

Conformity with EN 60-601 (§ 6.8.2 b):

“The manufacturer, assembler, installer or importer is not considered to be responsible themselves for the consequences on the safety, reliability and characteristics of a device unless:

- The assembly, fitting, extensions, adjustments, modifications or repairs have been performed by persons authorized by the party in question.
- The electrical installation of the corresponding premises complies with IEC regulations.
- The device is used in accordance with the instructions for use.”

If the replacement parts used for the periodic servicing by an approved technician do not comply with the manufacturer’s specifications, the latter is absolved from all responsibility in the event of an accident. Do not open the device while in operation: risk of electrical shock. This device complies with the requirements of the 93/42/EEC European directive but its operation may be affected by other devices being used close by, such as diathermy and high frequency electro-surgical equipment, defibrillators, short wave therapy equipment, mobile telephones, CB and other portable devices, microwave ovens, induction plates or even remote control toys and more generally electromagnetic interferences which exceed the levels specified by the EN 60601-1-2 standard.

Classification

Type of protection against electric shock:

Class II Protection from electric shock is achieved by DOUBLE INSULATION.
Protective earthing or reliance upon installation conditions is not required.

Degree of protection against electric shock:

Type B Equipment providing a particular degree of protection against electric shock, particularly regarding:

- 1) allowable leakage current;
- 2) Reliability of protective earth connection (if present).

Not intended for direct cardiac application.

Degree of protection against harmful ingress of water:

Equipment provided with an enclosure preventing entry of such an amount of falling liquid as might interfere with the satisfactory and safe operation of the equipment.

Method of cleaning and infection control allowed:

Please refer to the General Instructions section in the VisionAire Service Manual.

Degree of safety of application in the presence of flammable anesthetic gases:

Equipment not suitable for such application.

Mode of operation: Continuous duty.

1.3 Functional Specifications

Oxygen Concentration:	1-5 liters per minute at 90% +5.5/-3% 1-3 liters per minute at 90% +5.5/-3% (VisionAire 3) 1/8-2 liters per minute at 90% +5.5/-3% (VisionAire 2) (Based on 70°F [21°C] at sea level)
Accuracy:	± 10% of indicated flow setting, or ± 200 ml, whichever is greater.
Response Time:	Allow 5 minutes to attain maximum oxygen concentration.
Positioning:	Operate the unit in an upright position, maintaining at least 12 inches (30.5cm) of open space on all sides for ventilation.
Dimensions:	20.8 in. high, 14.1 in. wide, 11.5 in. deep (52.8 cm high, 35.8 cm wide, 29.2 cm deep)
Weight:	30 lb; shipping weight – 37 lb (13.6 kg; shipping weight – 16.7 kg)
Electrical (+/- 10%):	115VAC, 60 Hz, 3 amps, 290 watts 115VAC, 60 Hz, 3 amps, 190 watts (VisionAire 3) 115VAC, 60 Hz, 3 amps, 200 watts (VisionAire 2) 220-240 VAC, 50 Hz, 1.5 amps, 290 watts 220 VAC, 60 Hz, 1.5 amps, 290 watts 230 VAC, 50 Hz, 1.5 amps, 180 watts (VisionAire 2) 230 VAC, 50 Hz, 1.5 amps, 175 watts (VisionAire 3)
Alarms:	Power Failure Low Oxygen Concentration (with optional Oxygen Monitor) Low Pressure High Pressure High Temperature No Flow
Electrical Shock Protection:	Class II, Type B
Operating Temperature Range:	41 to 105°F (5 to 40°C)
Storage Temperature Range:	-4 to 140°F (-20 to 60°C)
Humidity:	15 – 95% (non-condensing)

2.0 Operational Check and Oxygen Concentration Test

2.1 Description of Operation

Air is drawn into the VisionAire Oxygen Concentrator. For overall, sound efficiency, before air enters the compressor, it passes through the unit's intake muffler. Pressurized air then exits the compressor and moves to the valve manifold. The valve manifold incorporates the use of five two-way solenoid valves which control the flow of air and oxygen in and out of the molecular sieve beds. The unique property of molecular sieve enables it to physically attract (adsorb) nitrogen when air passes through this material, thus producing high concentration oxygen.

There are two sieve beds: while one produces high concentration oxygen, the other is purged of the nitrogen it adsorbed (collected) during this pressure swing adsorption (PSA) cycle. Each adsorber produces oxygen and delivers it to the product tank. Oxygen exits the product tank through a pressure regulator, flow control valve, flow meter, and finally exits the unit. The VisionAire unit delivers up to 95.5% oxygen at the prescribed flow rate.

2.2 Operation Check

AirSep tests every VisionAire Oxygen Concentrator thoroughly after manufacture. You must perform the following test to ensure that no damage occurred in shipping or handling.



Do not use extension cords with this unit or connect too many plugs into the same electrical outlet. The use of extension cords could adversely affect the performance of the device. Too many plugs into one outlet can result in an overload to the electrical panel causing the breaker/fuse to activate or fire if the breaker or fuse fails to operate.

1. Open and inspect all cartons (that contain units) upon delivery. Unpack the unit and remove it from the carton. Inspect the unit itself for damage. If the exterior of a unit's carton is damaged, or the unit itself is damaged, note it on the freight bill signed by the driver.
2. Plug in the power cord of the unit, and set the I/O power switch to the "I" position. Check to see that the following occurs:
 - a. A continuous alarm sounds for approximately four seconds. See the troubleshooting chart in Section 5.0 of this manual if the unit's alarm does anything other than sound for four seconds.
 - b. The compressor runs and flow is indicated in flow meter.
 - c. OPTIONAL: The Oxygen Monitor's amber light will remain on for four minutes upon startup regardless of unit's concentration. After four minutes, the light will go out if the concentration level has reached minimum concentration requirements.
 - d. Perform an oxygen concentration test, as described in Section 2.4.

2.3 Alarm System

The VisionAire Oxygen Concentrator is equipped with an alarm system, which sounds an intermittent alarm when a power failure or other alarm condition occurs.

The intermittent alarm sounds are displayed in the following table:

VisionAire Intermittent Alarm Indicators

Condition	No Power	Low O2	Low Pressure	High Pressure	High Temperature	No Flow
Audible Alarm	One beep	Two beeps	Three beeps	Four beeps	Five beeps	Six beeps

If the high pressure alarm is activated, the compressor and valves will shut down, and the audible four-beep alarm will continue. This alarm remains on until you set the I/O power switch to the “0” position.

Refer to Section 5.0 for alarm identifications, and a list of probable alarm causes.

2.3.1 Start Up

Each time the VisionAire unit is turned on, an alarm should sound for approximately four seconds.

2.3.2 Power Failure Alarm Test

To test the power failure alarm, disconnect the unit from power, set the I/O power switch to the “I” position. This should activate the audible one-beep alarm.



If the unit has not been used for an extended period of time, it needs to operate for several minutes to recharge the power failure alarm.

2.3.3 No Flow Alarm Test

To test the no flow alarm, place thumb over oxygen outlet to completely block flow for approximately 10-15 seconds. The flow meter ball should drop to zero and the 6-beep alarm should be activated. (Note: not all units were originally manufactured with a no flow alarm. Units equipped with main circuit boards prior to rev. R will not have this feature.)

2.4 Oxygen Concentration Test and Specification

To ensure that the unit’s output of oxygen is within specification, you must perform a test of the oxygen concentration. Test the unit upon delivery to a patient and at periodic intervals. Equipment Providers need to establish and implement a protocol to check oxygen concentration.

1. If a humidifier bottle is used, disconnect it.
2. Connect a calibrated oxygen concentration analyzer to the oxygen outlet.
3. Verify that the product flow rate delivered by the unit matches the patient’s prescription and does not exceed the capacity of the unit.
4. Set the unit’s I/O power switch to the “I” position. Allow approximately five minutes for the oxygen concentration to stabilize. Take oxygen concentration readings and verify levels are within specification at the liter flow being tested.
5. Disconnect the oxygen analyzer, and reconnect the humidifier bottle.



Do not measure oxygen concentration output after the product stream passes through a humidifier bottle, or erroneous readings will result.





3.0 General Instructions

3.1 Instructions

It is important that patients thoroughly understand how to operate the AirSep VisionAire unit. This enables proper treatment as prescribed by a qualified, licensed health care provider/physician. If patients experience any discomfort or the unit alarms, they must notify their licensed health care provider/physician immediately.

You, as the Equipment Provider, are responsible to see that each patient receives the Patient Manual. Explain each step in the operation of the unit to the patient in reference to this manual.

	<p>Smoking while using oxygen is the number one cause of fire, injury, and death. You must follow these safety warnings:</p>
	<p>Do not allow smoking, candles, or open flames within the same room of the device or oxygen-carrying accessories.</p>
	<p>Smoking while wearing an oxygen cannula may result in facial burns and possibly death.</p>
	<p>Removing the cannula and placing it on surfaces such as bedding, sofas, or other cushion material will cause a flash fire when exposed to a cigarette, heat source, or flame.</p>
	<p>If you smoke, you must follow these 3 life-saving steps: turn off the oxygen concentrator, take off the cannula, and leave the room where this device is located.</p>

	<p>“No Smoking – Oxygen in Use” signs must be prominently displayed in the home or where the oxygen concentrator is in use. Patient and their caregivers must be informed about the dangers of smoking in the present of, or while using, medical oxygen</p>
	<p>This device supplies high-concentration oxygen that promotes rapid burning. Do not allow smoking or open flames within the same room of (1) this device, or (2) any oxygen-carrying accessory. Failure to observe this warning can result in severe fire, property damage, and /or cause physical injury or death.</p>
	<p>Electrical shock hazard. Disconnect the power cord from the electric outlet before you clean the unit to prevent accidental electrical shock and burn hazard. Only your Equipment Provider or a qualified service technician should remove the covers or service the unit.</p>
	<p>Care should be taken to prevent the VisionAire from getting wet or allowing any liquid to enter the unit. This can cause the unit to malfunction or shut down, and cause an increased risk for electrical shock or burns.</p>



Do not use liquid directly on the unit. Clean the exterior of unit and power cord only with a mild household cleaner applied with a damp cloth or sponge, and then wipe all surfaces dry.

3.2 Patient, Provider, and Routine Maintenance

AirSep does not require any preventative or routine maintenance on the VisionAire concentrator. VisionAire's unique design and technology allows for a virtually maintenance-free oxygen concentrator. You do not need to perform any maintenance as long as the VisionAire unit remains within specifications at the desired flow rate.



The VisionAire does not incorporate an external air intake gross particle filter or batteries that require replacement.

3.2.1 Product Filter – No Maintenance Required

The product filter is located internally within the unit's product tank. There is no requirement for replacement. It is designed to last for the life of the concentrator.

3.2.2 Preparing for New Patient Use/Method of Cleaning and Infection Control

When you remove the VisionAire from a patient's home or facility, always dispose of the used cannula and humidifier bottle. Clean the exterior of the VisionAire with soapy water solution or mild household cleaner applied with a damp cloth or sponge to remove any gross debris. Do not use liquid directly on unit, and be careful not to get liquid into the interior of the unit.



Next, following same guidelines above, clean the exterior with either a common chemical disinfectant or bleach solution*, wear eye and skin protection. After using the disinfecting solution, wipe entire unit with a cloth or sponge applied with water only, then wipe dry. Make sure unit is completely dry and then retest it before you return it to inventory.

* **The manufacturers of sodium hypochlorite products recommend various strengths of a bleach solution for killing bacteria, etc., based on the type of germ to disinfect; however, a generally recommended solution is ¾ cups of household bleach per gallon of water.**

4.0 Main Components

4.1 Components

The design of the VisionAire Oxygen Concentrator allows for easy access and removal of most components. This allows you to perform repair and replacement of parts with minimal time and effort.

 CAUTION	To prevent accidental electric shock or burn, be sure to set the unit's I/O power switch to the "0" position and unplug the power cord of the unit from the electrical outlet before you service the VisionAire Oxygen Concentrator.
 CAUTION	Some internal components, including the compressor may require cooling down before component removal. Care should be taken when removing all components.
 NOTE	Before reattaching tubing connections using a tie-wrap, remove 1/8 inch (0.32 cm) from end of tubing to assure a proper seal. Tubing should be cut evenly across width.

4.2 Cabinet Removal

4.2.1 Removing Front Panel

To remove the unit's front panel, locate and unscrew both ¼ turn fasteners located at the top of the unit.

4.2.2 Removing Back Panel

To remove the unit's back panel, locate and unscrew both ¼ turn fasteners located behind the humidifier bottle retaining strap within the humidifier bottle recess area of back panel.

4.3 Compressor

The compressor is the "pump" within the oxygen concentrator that pushes the room air into the top of the sieve beds. This allows oxygen to flow out of the bottom of the sieve beds in the VisionAire unit.

Two different aspects of the compressor cause concern: the output and the sound level.

Output

Compressor output refers to how much compressed air the compressor can produce. This depends upon the model of the compressor, stroke length, bore size, and cup seal condition. The cup seals form the seal between the piston and the cylinder wall. As the cup seals wear, the compressor's output begins to gradually decrease. This reduction in compressor output results in less air for the sieve beds. Therefore, the production of oxygen decreases.

Since this drop in oxygen production occurs over a long period of time, preventative maintenance on the compressor is not required. You can continue a patient's therapy on the VisionAire unit as long as that unit's oxygen concentration level at the prescribed flow rate is within AirSep's specifications.

Sound Level

The condition of the compressor's cup seals, bearings, and other components can result in an increased sound level. If the compressor's cup seals or bearings wear to the point that they become noisy, the concentrator may become noticeably louder, therefore compressor service or exchange may be required.

4.3.1 Compressor Replacement



Some internal components, including the compressor may require cooling down before component removal. Care should be taken when removing all components.

Compressor Assembly Removal

To remove the compressor assembly, follow the steps below:

1. Set the unit's I/O switch to the "0" position and unplug the power cord.
2. Remove the front panel of unit.
3. Remove screws securing the compressor cover to the compressor enclosure, and remove cover to access compressor assembly.
4. Locate the 2-pin wire connection labeled '*compressor*' on circuit board, and carefully disconnect connector from the circuit board.
5. Disconnect both wire connections from capacitor.
6. Remove the compressor by gently lifting it up and pulling it towards you at the same time.
7. Disconnect output tubing from left side of compressor assembly.

Compressor Assembly Installation

To install compressor assembly, follow the steps below:

1. Locate new compressor assembly.
2. Attach output tubing to compressor. Turn tubing ¼ turn in counter-clockwise direction and hold in that position while tightening fitting. If this is not done, the compressor will lean forward and contact the enclosure cover.
3. Assure compressor assembly is installed correctly. All four compressor springs must be installed on to their corresponding spring guides located on the bottom of the compressor compartment.
4. The end of the temperature probe must be located within the compressor compartment and positioned behind the compressor wires before installing the compressor cover.
5. Care should be taken when reconnecting wire connections to the circuit board and capacitor. Both sets of wires from compressor must be routed properly through the loop on tie wrap mount located inside of the compressor compartment, up through the small recessed area of compressor compartment in front of temperature probe, and alongside the back of capacitor to avoid possible damage when front cover is installed.
6. Compressor wires must be allowed to freely move within tie wrap loop. Care must be taken to assure compressor wires are not pulled by loop of tie wrap mount when properly installed. If new tie wrap is needed, it is important to engage only the first few notches of the tie wrap.
7. Before installing compressor cover, assure compressor wires are not in contact with compressor.
8. Leak test output tubing connection of compressor.

4.3.2 Capacitor Replacement

The capacitor starts the compressor. If the compressor cannot start, the capacitor may be defective and require replacement. To replace the capacitor, follow the steps below:

1. Set the unit's I/O switch to the "0" position and unplug the power cord.
2. Remove front panel and locate capacitor.
3. Gently slide entire compressor enclosure towards you to allow easier access to the capacitor. (Do not pull out enclosure too far as damage may occur to certain components within concentrator).
4. Carefully disconnect both wire connections from the capacitor, slide capacitor out from tie-wrap.
5. To install new capacitor, slide capacitor into the tie-wrap holding it in place, and connect both wire connections to capacitor. Tie-wrap should be centered on capacitor when properly installed.
6. Return compressor enclosure to its original position, reinstall front cover.

4.4 Solenoid Valves

The VisionAire uses five two-way solenoid valves: two feed, two waste, and one equalization. Each valve has an open (energized) and closed (de-energized) position. As the VisionAire operates, two or three valves are always energized. The solenoid valves of the VisionAire unit require no scheduled maintenance.

4.4.1 Valve Manifold Replacement

Valve Manifold Removal

To remove the valve manifold, follow the steps below:

1. Set the unit's I/O switch to the "0" position and unplug the power cord.
2. Remove both front and back panels.
3. Remove the compressor assembly by following the compressor removal procedure outlined under section 4.3.1.
4. Remove tubing attached to the exhaust muffler assembly. Do not remove muffler assembly.
5. Disconnect small tubing from the in-line adaptor leading to the sensor located on the circuit board.
6. Disconnect the wire connectors labeled *AC Power* and *PowerSw* from circuit board. (If equipped with an O₂ oxygen monitor, also disconnect wire connectors labeled *O₂ LED* and *Sensor*).
7. From back of unit, disconnect tubing connections at the equalization valve and disconnect fittings from top of both sieve beds.



Temporarily seal sieve bed openings with tape to prevent the sieve material from being exposed to the moisture in room air. Prolonged exposure to room air results in contamination and permanent damage to the sieve material.

8. With adjusting compressor enclosure (alternating pulling out top and bottom), gently remove the compressor enclosure from the center section of unit by sliding it out through the front.
9. With the compressor enclosure completely removed, carefully remove all valve retainer clips and coils from each valve stem. Wire connectors can remain

attached to coils for easier installation. (Please refer to the Valve Wire Harness drawings WH105-1 located on page C in the Appendix section of this manual as needed)



Care must be taken when removing and installing valve coil retainer clips.

10. Using 1/8-inch Allen wrench, remove mounting bolt securing the manifold to the center section. Remove manifold assembly from compressor enclosure.
11. With the tubing still attached from the exhaust muffler and compressor, remove the fittings and tubing located on the underside of the valve manifold using a 7/16-inch open end wrench.
12. Disconnect fittings and remove the sieve bed feed tubing from manifold using a 9/16-inch open end wrench.
13. Disconnect small tubing from both sides of the valve manifold.

Valve Manifold Installation

To replace the valve manifold, follow the steps below:

To follow this procedure easier, view the manifold from the front when reassembling components to manifold. Equalization valve will be positioned in the front of manifold when viewed this way.

1. Perform the valve manifold removal procedure in reverse order.
2. When installing the fittings from the sieve bed tubing, do not over tighten.
3. Remove original sealant tape from threads on fittings which will be installed to underside of manifold. Apply new sealant tape to fittings before installation.
 - a. Fitting with braided tubing attached (compressor) must be installed to the left underside of manifold. Fitting with tubing attached (exhaust muffler) must be installed to the right underside of manifold.
 - b. Foam pieces should be in place over fittings before installing manifold to compressor enclosure.
4. Valve manifold must be positioned properly before installation. When positioned correctly, the front of the valve manifold will face towards the back of the compressor enclosure, and will rest on the support pins on top of the enclosure.
5. When installing coils onto manifold valve stems, view manifold from the front.
 - a. The front valve stem is the equalization valve and its coil should be installed having the wire terminals positioned on the bottom of the valve stem. The other coils must be installed having their wire terminals located on top of their valve stems.
 - b. The outside (feed) valve coils must be installed so their wire terminals are pointing towards the front of manifold.
 - c. The inside (exhaust) valve coils must be installed so their wire terminals are pointing towards the back of manifold.
 - d. Valve coil retainer clips must be installed correctly so that the open ends are pointing downward on top of valve coil.
6. Periodic adjustment of the compressor enclosure may be required when reinstalling into center section.

- a. Care must be taken not to pinch any wires or tubing between the compressor enclosure and center section before final installation.
 - b. The wire harness for both the left feed valve and the equalization valve, along with the wire harness for the right feed valve, must be routed outside of the valve manifold assembly before connecting to valve coils.
 - c. The AC I/O power switch wire harness and the pressure tubing to the circuit board sensor must be routed to the outside of the manifold assembly and along the back of the capacitor before installation.
7. When reinstalling fittings to top of the sieve beds, ensure wires and tubing on both sides are located inside of these connections.
 8. If equipped with an O₂ oxygen monitor, be sure to reconnect wire connections labeled *O₂ LED* and *Sensor* to circuit board.
 9. When reattaching tubing to exhaust muffler, be sure to secure with tie-wrap.
 10. Install the compressor assembly by following the compressor assembly installation procedure outlined under section 4.3.1.

4.4.2 Solenoid Valve Coil Replacement

An ohmmeter can be a useful tool in determining the condition of a valve coil. When using an ohmmeter, each valve coil should be between 713 – 837ohms.

To replace a solenoid valve coil, follow the steps below:

1. Set the unit's I/O switch to the "0" position and unplug the power cord.
2. Remove back panel.
3. Carefully remove valve retaining clip from coil to be replaced.
4. Disconnect both wire connectors from solenoid valve, lift coil off of valve stem.
5. Install new coil on valve stem, reinstall coil retaining clip, and reconnect both wire connectors to coil.
6. Valve coil retainer clips must be installed correctly so that the open ends are pointing downward on top of valve coil.

4.5 Sieve Beds

The VisionAire unit utilizes two sieve beds each containing molecular sieve. The unique property of molecular sieve enables it to physically attract nitrogen when air passes through this material, thus producing high concentrated oxygen.

While one sieve bed produces high-concentration oxygen, the other is purged of the nitrogen it adsorbed (collected) while it concentrates oxygen. Each adsorber (sieve bed) produces oxygen and delivers it to the mixing tank.



VisionAire 2 uses different sieve beds (**BE187-4**) than VisionAire or VisionAire 3 (**BE187-2**). The beds look the same but use different molecular sieve (SI015-1 for V2).

4.5.1 Sieve Bed Replacement



Temporarily seal sieve bed openings with tape to prevent the sieve material from being exposed to the moisture in room air. Prolonged exposure to room air results in contamination and permanent damage to the sieve material.



Leaks can be so small in air loss that oxygen concentration is not affected immediately. The sieve material can become contaminated gradually. Careful leak testing is important as the sieve material can become contaminated gradually with very small leaks.



If replacement is necessary, you must replace both sieve beds at the same time.

Sieve Bed Removal

To remove sieve beds, follow the steps below:

1. Set the unit's I/O switch to the "0" position and unplug the power cord.
2. Remove back panel.
3. Remove the fitting on the top of each sieve bed.
4. While keeping the four large sieve bed tie-wraps in place, gently pull upwards on the top tie-wrap and remove each bed.
5. Lift each sieve bed from bottom tie-wrap and disconnect product tubing located at bottom of each bed connection.

Sieve Bed Installation

To install the sieve beds, follow the sieve bed removal procedure in reverse order. All tubing connections must be tightened properly to eliminate leaks. (Do not over tighten fittings.)

To check for leaks, take the following steps:

1. Plug unit in and set the unit's I/O switch to the '1' position.
2. Allow unit to run for three minutes.
3. Apply soapy water solution around tubing connections on both sieve beds, and check for leaks.

4.6 Cabinet Fan

The cabinet fan pulls ambient air into the VisionAire unit. As this air is drawn in, the air cools internal components (including the compressor) and exits out the bottom of the unit.

4.6.1 Cabinet Fan Replacement



Periodic adjustment of the compressor enclosure may be necessary during this process.

Cabinet Fan Removal

To replace the cabinet fan, follow the steps below:

1. Set the unit's I/O switch to the "0" position and unplug the power cord.
2. Remove both front and back panels.
3. From back of unit, disconnect tubing connections at the equalization valve and disconnect fittings from top of both sieve beds (Temporarily seal sieve bed openings with tape to prevent the sieve material from being exposed to the moisture in room air.)
4. From the front of the unit, disconnect small tubing from the in-line adaptor leading to the sensor located on the circuit board.

5. Disconnect the wire connectors labeled *AC Power* and *PowerSw* from circuit board. (If equipped with an O2 oxygen monitor, also disconnect wire connectors labeled *O2 LED* and *Sensor*).
6. With adjusting compressor enclosure (alternating pulling out top and bottom), gently remove the compressor enclosure from the center section of unit by sliding it out through the front.
7. Locate cooling fan at the back of the compressor enclosure. Review of both the cooling fan and its wire connection positions should be made prior to fan removal to allow easier and proper installation of new fan.
8. Remove fan and foam strip from the fan recess area and disconnect wires at proper locations.

Cabinet Fan Installation

To install the cabinet fan, follow the steps below:



It is very important to install the cabinet fan correctly. Reference to arrow indicating airflow direction must be made. Improper installation of cabinet fan may result in unit to overheat and shutdown.

1. Locate arrow on fan indicating airflow direction. The arrow for airflow must be pointing towards the compressor when properly installed.
2. Install wire connections onto new fan. Depending on the replacement fan version being installed, wire connections on fan should be positioned either in the top left or lower right positions when properly installed.
3. Replace foam strip around housing of new fan. Opening of foam should be positioned at the upper right corner of fan when installed, and wires from fan connections routed through same opening of foam at this location.
4. Position both foam strip and cabinet fan into fan recess area located at the back of the compressor enclosure. When properly installed, both foam strip and fan must be flush with the edge of fan recess area.
5. Return compressor compartment to the original position, being careful not to pinch any tubing or wires between compressor enclosure and center section of unit.
6. After removing tape from the top of each sieve bed, reconnect and tighten fittings. (Small tubing from the bottom sieve beds and the unit's power cord should be located inside and underneath the tubing connected to sieve beds.
7. Reconnect and secure tubing to equalization valve using tie-wraps.
8. Reconnect wire connectors to main circuit board labeled *AC Power* and *PowerSw*. (If equipped with an O2 oxygen monitor, also reconnect wire connections labeled *O2 LED* and *Sensor*).
9. Reattach small tubing to the in-line adaptor leading to the sensor located on the circuit board, secure with tie wrap.
10. Leak test tubing connections and assure fan is rotating properly.

4.7 Circuit Board

The solid-state printed circuit board controls the timing operation of the five solenoid valves, the alarm system functions, and regulates the voltage to ensure efficient and optimal performance.



The Printed Circuit Boards (PCBs) contain components that are sensitive to electrostatic discharge (ESD) and can damage the board if not handled properly. As when handling any ESD-sensitive PCB, observe standard ESD safety procedures.

4.7.1 Circuit Board Replacement

Circuit Board Removal

To remove the circuit board, follow the steps below:

1. Set the unit's I/O switch to the "0" position and unplug the power cord.
2. Remove both front and back panels.
3. In viewing unit from the back, remove fittings from top of both sieve beds. (This step will allow easier access to circuit board when the compressor enclosure is moved). Temporarily seal sieve bed openings with tape to prevent the sieve material from being exposed to the moisture in room air.
4. In viewing unit from the front, locate circuit board and cut tie-wrap securing tubing to the transducer on circuit board. Carefully remove tubing from circuit board sensor.



Care must be taken when removing and installing tubing to circuit board sensor to prevent damaging sensor.

5. Gently slide entire compressor enclosure towards you to allow access to wire connections located at the back of the circuit board. (Do not pull out enclosure too far as damage may occur to certain components within concentrator).
6. Locate and remove the 2-pin wire harness labeled '*Compressor*' on circuit board.
7. In a clockwise manner, remove remaining wire harnesses from circuit board. These are wire harnesses labeled: *AC Power*, *Buzzer*, *PowerSw*, *Temp Switch*, *Fan*, and the 6-pin wire harness located at the back of the circuit board labeled '*Valves*'.



If unit is equipped with an O2 monitor system, there will be two additional wire harness connections labeled *O2 LED* and *Sensor* that should be disconnected from the circuit board before removal.

8. Using a Phillips-head screwdriver, remove screws securing circuit board in place.

Circuit Board Installation

To install the circuit board, follow the steps below:

1. Located at the back of the circuit board, reconnect wire harness to connection labeled *Valves* on circuit board.
2. Care should be taken when reconnecting any wire harness to assure they are installed properly.
3. Perform the remaining steps listed in the circuit board removal procedure in reverse order.
4. Replace compressor enclosure to its original position and reconnect fittings to the top of each sieve bed, being careful not to over tighten.
5. Install tubing to the top barb of transducer located on the circuit board. Secure with tie-wrap.

6. Leak test fitting connections of sieve beds.

4.8 Product Regulator Check and Setting

The product regulator enables you to set the maximum flow of oxygen output by the VisionAire unit. To check for proper adjustment of the regulator, take the following steps:

1. Set the I/O power switch to the “I” position.
2. Allow the unit to run for five minutes.
3. Turn the flow meter adjustment knob counterclockwise until it stops (wide open).
4. The flow meter ball should be set to $\frac{1}{2}$ liter **above** the maximum flow rate. If not, the product regulator needs to be reset.

4.8.1 Setting Product Regulator for Normal Operation

Use the following procedure to reset the product regulator:

1. Disconnect the humidifier bottle, if used, and the tubing from oxygen outlet.
2. Plug in the unit.
3. Set the unit’s I/O power switch to the “I” position, and allow unit to run five minutes to build up pressure.
4. Turn the flow meter adjustment knob counterclockwise until it stops (wide open).
5. Remove the back panel of unit.
6. Pull outward on the regulator knob to unlock it.
7. Turn the regulator knob (clockwise to increase) until flow meter ball is set to $\frac{1}{2}$ liter above the maximum flow rate .
8. Push in the regulator knob to lock it.
9. Reconnect the back panel.

4.8.2 Product Regulator Lockout

Take the following steps to limit the maximum flow of the oxygen concentrator:



It may be desirable to provide one additional liter or oxygen flow above the prescribed level of concentration in using the lockout feature

1. Plug in the unit.
2. Set the unit’s I/O power switch to the “I” position, and allow the unit to run five minutes to build up pressure.
3. If used, connect the humidifier bottle, oxygen tubing, and cannula to the oxygen outlet.
4. Remove the back panel of unit.
5. Turn the flow meter adjustment knob counterclockwise until it stops (wide open).
6. Pull outward on the regulator knob to unlock it.
7. Turn the regulator knob counterclockwise to decrease the setting until the flow meter registers the maximum flow desired.
8. Push in the regulator knob to lock the setting.
9. Reconnect the back panel.



When the lockout adjustment is no longer required, follow the normal regulator setting procedure as described in Section 4.8.1.

4.8.3 Back Pressure Correction at Maximum Flow Rate

In some cases, additional lengths of oxygen tubing with a humidifier bottle can increase back pressure and limit oxygen flow below the maximum flow setting.

To achieve full maximum flow setting, use the following procedure:

1. Plug in the unit.
2. Set the unit's I/O power switch to the "I" position, and allow the unit to run five minutes to build up pressure.
3. Connect the humidifier bottle, oxygen tubing, and cannula to the oxygen outlet.
4. Turn the flowmeter adjustment knob counterclockwise until the ball reaches the stop at the top of the flow meter (wide open).
5. Remove the back panel of unit.
6. Pull outward on the regulator knob to unlock it.
7. Turn the regulator knob clockwise until flow meter ball is set $\frac{1}{2}$ liter above the maximum flow rate .
8. Push in the regulator knob to lock the setting.
9. Turn the flowmeter adjustment knob clockwise until the flowmeter indicates maximum flowrate.
10. Reconnect back panel.



When this back pressure correction is no longer required, follow the normal regulator setting procedure as described in Section 4.8.1.

4.8.4 Product Regulator Cleaning or Rebuilding

Clean or rebuild the product regulator if the flow meter ball fluctuates more than $\frac{1}{4}$ liter or if the regulator cannot be adjusted for lockout.

1. Set the unit's I/O switch to the "0" position and unplug the power cord.
2. Remove the back panel.
3. Use large pliers to unscrew the bonnet of the product regulator, which contains a large spring.



Adjust the product regulator fully counterclockwise to unload the spring. This makes disassembly and reassembly easier.

4. Remove the diaphragm. (Clean or replace it.)
5. Using a Phillips-head screwdriver, unscrew the diaphragm stem guide located in the center of the regulator body to gain access to the seat.
6. Remove the seat. Be careful not to lose the spring located behind the seat.
7. Clean or replace the seat.

8. With the spring behind the seat, screw the diaphragm stem guide back into the body of the regulator. (Do not over tighten.)
9. Install a clean or replacement diaphragm.
10. Put the large spring and slip ring into the bonnet, and screw the bonnet onto the regulator body.
11. Reset the product regulator as described in Section 4.8.1.

4.9 Circuit Breaker Replacement

Circuit Breaker Removal

To remove the circuit breaker, follow the steps below:

1. Set the unit's I/O switch to the "0" position and unplug the power cord.
2. Remove the front panel and locate circuit breaker.
3. To gain access to the underside of the circuit breaker, remove screw securing the right mounting plate assembly to the center section using a Phillips-head screwdriver.
4. Lift assembly out from unit and disconnect wires from circuit breaker.
5. Remove the securing ring holding the circuit breaker to the mounting plate.

Circuit Breaker Installation

Follow the removal procedure for the circuit breaker in reverse order to install the new circuit breaker. Wire connections on circuit breaker can be made to either terminal.

4.10 I/O Power Switch Replacement

I/O Power Switch Removal

To remove the I/O power switch, follow the steps below:

1. Set the unit's I/O switch to the "0" position and unplug the power cord.
2. Remove the front panel and locate the I/O power switch.
3. To gain access to the underside of the switch, remove screw securing the right mounting plate assembly to the center section using a Phillips-head screwdriver.
4. Lift assembly out from unit and disconnect wires from switch.
5. To allow easier access to the I/O power switch, remove the circuit breaker from mounting plate, leaving wires connected. (Refer to circuit breaker removal procedure 4.9.1).
6. With circuit breaker removed, use large adjustable pliers to unlock the top and bottom securing tabs of power switch while pushing power switch through front of mounting plate at the same time.

I/O Power Switch Installation

Follow the removal procedure for the I/O power switch in reverse order to install a new power switch.

1. Be sure to reinstall the new switch properly by having the '0' on the switch located on the bottom when finished.
2. Wire connections on the left side of switch should be from circuit breaker and hourmeter wires. Wire connections on the right side of switch from the circuit board wires. (The smaller size wires are from the circuit board.)
3. Same side wire connections of power switch can be made to either terminal.

4.11 Hour Meter Replacement



FOR P/N: HM009-2 ONLY: HM009-2 is a dual timer hour meter.
To toggle between the two display screens - press the pinhole reset switch once to display “TMR1” mode.
To reset the timer display – confirm that “TMR1” is displayed in the upper left corner. Press and hold the pinhole reset switch for 3 seconds until 0.0 is displayed.

Hour Meter Removal

To remove the hour meter, follow the steps below:

1. Set the unit’s I/O switch to the “0” position and unplug the power cord.
2. Remove front panel and locate hour meter.
3. To gain access to the underside of the hour meter, remove screw securing the right mounting plate assembly to the center section using a Phillips-head screwdriver.
4. Lift assembly out from unit and disconnect wires from hour meter.
5. While pressing in the securing tabs located in each corner of hour meter, push hour meter through the front of the mounting plate. (It may be easier to perform this step to one side of the hour meter at a time.)

Hour Meter Installation

To install a new hour meter, follow the steps below:

1. Follow the removal procedure for the hour meter in reverse order.
2. Be sure to reinstall the new hour meter properly by having the ‘hourglass’ icon located on the bottom when finished.
3. The top two hour meter wire connections should be from the white wire from power cord and the white wire from the circuit board harness.
4. The lower two hour meter wire connections should be from the black wire from the I/O power switch and the black wire from the circuit board harness.
5. Connections for the same color wires can be made to either terminal.

4.12 Flow meter Replacement



Care must be taken when removing and installing the flowmeter on units equipped with an O2 monitoring systems to prevent damaging circuit board sensor. The tubing assembly from the top of the flow meter is connected to sensor.

Flowmeter Removal

To remove the flow meter, follow the steps below:

1. Set the unit’s I/O switch to the “0” position and unplug the power cord.
2. Remove the front panel and locate flow meter.
3. To gain access to the underside of the flow meter, remove screw securing the left mounting plate assembly to the center section using a Phillips-head screwdriver.
4. Carefully lift assembly out from unit.
5. Cut only the top tie-wraps on each tubing connection of flow meter and disconnect tubing from flow meter.
6. Remove flow meter nuts securing flow meter to the mounting plate, remove flow meter.

Flowmeter Installation

1. To install a new flow meter, follow the flow meter removal procedure in reverse order. Leak test the tubing connections.
2. Assure flow meter reads $\frac{1}{2}$ liter above the maximum flow rate when fully opened. (Refer to section 4.8 Product Regulator Check and Setting for proper adjustment as needed).
3. To avoid the possibility of activating no flow alarm, set flow meter to desired liter flow prior to turning unit off.

4.13 Power Cord Replacement

Power Cord Removal

To remove the power cord, follow the steps below:

1. Set the unit's I/O switch to the "0" position and unplug the power cord.
2. Remove both front and back panels.
3. Using a Phillips-head screwdriver, remove screw securing the right mounting plate assembly from the center section.
4. Carefully pull out assembly and disconnect the power cord wire connections from the hourmeter (white) and circuit breaker (black).
5. From the back of unit, completely pull power cord out of holder and unwrap the power cord wires from the ferrite bead (ring). Please note configuration of wires around the ferrite ring at this time. Do not dispose ring.
6. Using large adjustable pliers, remove power cord strain relief from base of unit by pressing in the top and bottom of the strain relief while pulling out towards you at the same time.

Power Cord Installation

To install a new power cord, follow the steps below.

1. Place both new power cord and old power cord together (side-by-side) to determine location to install strain relief on new power cord.
2. Route both wire ends of new power cord into entry location on the base of unit and pull power cord through hole to the pre-determined location to install strain relief to new power cord.
3. Install strain relief onto power cord and secure power cord to base.
4. Locate ferrite ring and insert both wire leads from new power cord into the center of ferrite ring so that the outside insulation of power cord is flush with the inside rim of ferrite ring.
5. Continue to wrap both power cord wires around and through the center of ferrite ring 6 times. (The last few times will require wires to be inserted individually one at a time into center of ferrite ring.)
6. Insert power cord into holding clamps located to the right of the left sieve bed, and route the power cord to the inside of the top left sieve bed tubing connection.
7. Reconnect the white wire from power cord to the hour meter and the black wire from power cord to the circuit breaker.
8. Reinstall right mounting plate assembly to center section using a Phillips-head screwdriver.
9. When properly installed, ferrite ring should be located in the recessed area behind the right mounting plate assembly.
10. Reinstall both covers and turn unit on to confirm operation.

4.14 Oxygen Monitor Circuit Board Replacement (In Equipped Units)

Oxygen Monitor Circuit Board Removal

To remove the circuit board, follow the steps below:



Care must be taken when removing and installing tubing to circuit board sensor to prevent damaging sensor.

1. Set the unit's I/O switch to the "0" position and unplug the power cord.
2. Remove both front and back panels.
3. When viewing unit from the back, locate oxygen monitor circuit board and remove the tie-wraps at tubing connections.
4. Carefully remove tubing from circuit board sensor.
5. Disconnect wire harness from circuit board.
6. Using Phillips-head screwdriver remove screws securing circuit board to center section. Remove circuit board.

Oxygen Monitor Circuit Board Installation

To install a new circuit board, follow the removal procedure in reverse order.

4.15 Mixing Tank Replacement



VisionAire 2 uses an empty mixing tank assembly PN: TA004-1

Mixing Tank Removal and Installation

To replace the mixing tank, follow the steps below:

1. Set the unit's I/O switch to the "0" position and unplug the power cord.
2. Remove both front and back panels.
3. When viewing unit from the back, locate mixing tank and cut tie-wraps securing the mixing tank to the center section. (Do not remove tie-wraps at this time.)
4. Disconnect tubing connections from the mixing tank before removing it.
5. After review of correct installation is made, remove the tie-wraps which held the mixing tank in place. Install new tie-wraps to secure mixing tank to center section. Do not tighten tie-wraps at this time.
6. Reconnect tubing to mixing tank, secure tubing with tie-wraps.
7. Position mixing tank into place and tighten tie-wraps to secure.



Before final installation, care must be taken when installing new tie-wraps and the mixing tank to avoid pinching any tubing or wires. Inspection for this should be thoroughly made before final installation.

4.16 Exhaust Muffler Replacement

Exhaust Muffler Removal and Installation

To replace the exhaust muffler, follow the steps below:

1. Follow steps 1-7 in the Compressor Assembly Removal procedure outlined under section 4.3.1.
2. Locate exhaust muffler assembly in back of compressor enclosure, cut tie-wrap securing it in place.
3. Remove tie-wrap from tubing connection, disconnect tubing.
4. Unscrew the top half (exhaust muffler) from exhaust muffler body.
5. Install new exhaust muffler to the muffler body, being careful not to over tighten to prevent damaging threads of exhaust muffler.
6. Remove back panel.
7. To install tie-wrap for new muffler assembly, the compressor enclosure is required to be pulled out toward the front of unit. To allow greater access, remove tubing connections at the equalization valve, and disconnect the fittings from both sieve beds. (Temporarily seal sieve bed openings with tape to prevent the sieve material from being exposed to the moisture in room air.)
8. From the front of the unit, gently slide entire compressor enclosure towards you. (Do not pull out enclosure too far as damage may occur to certain components within concentrator.)
9. Starting from inside the compressor compartment, install new tie-wrap through the bottom opening located in the recessed area where the exhaust muffler assembly will be installed. (*Hint*: it may be easier if the end of the tie-wrap is formed into a 'hook' shape before this step.)
10. Route tie-wrap up the back of the compressor compartment and into the top opening of the compressor enclosure. When finished, both ends of tie-wrap should be located inside the compressor enclosure.
11. Reattach tubing to exhaust muffler assembly securing with tie-wrap.
12. Place muffler assembly into recessed area, securing with installed tie-wrap.
13. Return compressor compartment to the original position, being careful not to pinch any tubing or wires between compressor enclosure and center section of unit.
14. Reinstall compressor assembly following the Compressor Assembly Installation procedure outlined under section 4.3.1.
15. Reconnect and tighten fittings to top of sieve beds. Bottom sieve bed tubing and the unit's power cord should be located inside these tubing connections.
16. Reconnect and secure tubing to equalization valve using tie-wraps.
17. Leak test tubing connections on sieve beds and equalization valve.

4.17 Caster Replacement

Caster Removal

To replace a caster, it is necessary to remove the base of unit from the center section. To do this, follow the steps below:

1. Set the unit's I/O switch to the "0" position and unplug the power cord.
2. Remove both front and back panels.
3. Remove compressor cover from the compressor enclosure to access front screws securing center section to base.
4. Using a Phillips-head screwdriver, remove the screws in the front and back of unit securing the base of unit to the center section.

5. Gently position the entire concentrator on its back and separate the base from the center section. (Power cord is still attached to base.)
6. From the underside of base, secure caster nut (located just above the wheel of caster) using a 1/2-inch combination wrench.
7. While securing the nut, remove the top nut of caster using a 9/16-inch combination wrench.

Caster Installation

To install a caster, follow the removal steps in reverse order.

1. Larger washer should be installed onto caster before inserting into underside of base.

4.18 Roller Base Replacement

Roller base removal and Installation

To replace the base on the VisionAire concentrator, please follow the steps below.

1. Set the unit's I/O switch to the "0" position and unplug the power cord.
2. Remove both front and back panels.
3. Follow Power Cord Removal procedure outlined under section 4.13.1.
4. Remove compressor cover from the compressor enclosure to access front screws securing center section to base.
5. Using a Phillips-head screwdriver, remove the screws in the front and back of unit securing the base of unit to the center section.
6. Gently position the entire concentrator on its back and separate the base from the center section.
7. Follow Caster Replacement procedure outlined under section 4.17 to remove casters and install onto new base.
8. Install center section onto new base making sure the power cord location on the base is located at the back of the unit. Secure base to center section with screws using a Phillips-head screwdriver.
9. Follow Power Cord Installation procedure outlined under section 4.13.2. (Note: location of strain relief on power cord is already determined.)
10. Using a Phillips-head screwdriver, reinstall compressor cover to compressor enclosure.

4.19 Air Outlet Option (if equipped)

The air outlet option enables the VisionAire unit to serve as a source of compressed air for patients who require a medication treatment.

The air outlet valve and adaptor located externally on the unit's center section allows for an easy connection of tubing to be used for this application.

Checking/Setting the Air Outlet Pressure Regulator

To check/set the air outlet pressure regulator, please follow the steps below:

1. Set the unit's I/O switch to the "I" position and set flowmeter ball to 5lpm.
2. Locate air outlet port on the center section of concentrator. With pressure gauge attached to air outlet fitting (p/n F0725-1), insert fitting into air outlet port. Fitting will be locked in place when properly installed.
3. Verify pressure reading on gauge is 13-15psi (90–103 kPa). Remove and reinstall outlet fitting into outlet port, verify second pressure reading is the same.
4. If air outlet regulator requires adjustment, turn clockwise to increase pressure. If adjustment is needed, verify two consecutive pressure readings are within specification.
5. Remove outlet fitting from outlet port.

5.0 Troubleshooting

5.1 Operating Pressure Test

Testing the operating pressure is a useful diagnostic tool when a concentrator has low oxygen concentration and requires servicing. Units functioning normally do not require operating tests.

Use the following procedure to test the operating pressure of the unit:

1. Set the unit's I/O power switch to the "0" position, and unplug the power cord.
2. Remove the front panel of unit.
3. Locate the pressure test port location (black tube located on the top right side between the compressor enclosure and center section). Using a pressure test adapter (AirSep p/n: KI257-2), connect the pressure gauge to the test port.
4. Plug in the power cord, and set the unit's I/O power switch to the "1" position.
5. Set the flowmeter to the maximum flow rate for the unit and allow it to run five minutes.
6. Observe the maximum and minimum readings on the pressure test gauge.

The maximum reading should not exceed:

VisionAire:	30 psig (207 kPa)
VisionAire 2:	25 psig (172 kPa)
VisionAire 3:	25 psig (172 kPa)

The minimum reading should not be less than:

VisionAire:	8 psig (55 kPa)
VisionAire 2:	7 psig (48kPa)
VisionAire 3:	7 psig (48kPa)



When you turn the unit on, the system pressure always registers higher than normal for the first few minutes of operation.

5.1.1 High Operating Pressure

Higher than normal operating pressure may indicate any of the following:

- A restrictive exhaust muffler, which does not allow the waste (purge) gas to exit the system freely. Operate the unit with the exhaust muffler disconnected to see if the operating pressure returns to normal.
- An improperly operating circuit board or solenoid valve.
Confirm that the circuit board and solenoid valve function properly.
- Contaminated sieve beds.
Change the sieve beds.

5.1.2 Low Operating Pressure

If the oxygen concentration level at the desired liter flow is within AirSep's specifications, no service is required, even if operating pressure is low. If concentration is below specifications at the desired liter flow rate with low operating pressure, this may indicate any of the following:

- A restriction in the compressor intake path may be limiting the amount of room air available to the compressor.

Check compressor intake path for obstruction. Clean/remove obstruction and verify normal operating pressure returns.

- An improperly operating circuit board or solenoid valve.
Confirm that the circuit board and solenoid valve function properly.
- A leak in the unit, which allows system pressure to escape.
Leak test unit.
- A compressor with reduced output. If it is below specifications, replace or repair the compressor.

5.2 General Troubleshooting

Before reviewing the troubleshooting chart, the following steps may be useful to isolate any malfunctions:

1. Turn on the concentrator. If the unit does not turn on, refer to the troubleshooting chart.
2. Turn the flow meter knob until it is wide open at the highest setting. The ball should be located $\frac{1}{2}$ liter above the maximum flow rate. If the flow meter ball is not located at this setting, adjust the regulator until the ball is set **$\frac{1}{2}$ liter above** the maximum flow rate with the flow meter completely open.
3. Make sure the unit is cycling properly by:
 - a. observing the flow meter ball is stable (flow meter ball does not move up and down more than $\frac{1}{4}$ liter.)
 - b. checking circuit board if high or low pressure lights are illuminated and audible pressure alarm is sounding.
4. Place your thumb over outlet of unit. The flowmeter ball should drop to the bottom of the flowmeter. If the ball does not drop completely to the bottom, there is a leak present between the top of the flowmeter and the outlet of the unit.
5. If concentrator is not meeting specifications, make sure that the unit is leak-free by testing all tubing connections and fittings with leak testing solution. Protect circuit board(s) from solution and start leak test at the compressor, following air flow of unit to oxygen outlet. Repair all leaks by tightening connections and fittings.
6. If unit is alarming, refer to the Alarm Indicator Chart in Section 2.3 for probable solutions.
7. Set the concentrator at the maximum flow rate and connect an operating pressure test gauge to unit. Determine pressure parameters by observing high and low pressure points on the gauge. If pressures are high or low, refer to Section 5.1.
8. Review troubleshooting chart to isolate and repair any other malfunctions.

5.3 Troubleshooting Chart

Problem	Probable Cause	Solution
<i>Unit does not run. I/O power switch in “I” position.</i>	<ul style="list-style-type: none"> • No power to unit. • Unit circuit breaker tripped/faulty • Faulty electrical connections. • Faulty circuit board. • Faulty I/O power switch. 	<ul style="list-style-type: none"> • Check wall outlet for power. • Reset or replace circuit breaker. • Check electrical connections. • Replace circuit board. • Replace I/O power switch.
<i>Compressor runs with intermittent alarm. Oxygen concentration at max flow rate is within specifications.</i>	<ul style="list-style-type: none"> • Faulty pressure transducer. 	<ul style="list-style-type: none"> • Replace circuit board.
<i>Compressor runs and shuts down periodically. Only start up alarm activates</i>	<ul style="list-style-type: none"> • Faulty oxygen monitor circuit board. 	<ul style="list-style-type: none"> • Replace oxygen monitor circuit board.
<i>Compressor runs and shuts down periodically with 5-beep intermittent high temperature alarm.</i>	<ul style="list-style-type: none"> • Restricted air flow. • Unit overheating due to improper location. Compressor thermally cut off due to excessive heat. NOTE: It will not restart until it cools down. • Faulty cabinet fan. • Temperature probe wire harness faulty or disconnected from circuit board. 	<ul style="list-style-type: none"> • Remove obstruction. • Locate unit away from heating source, providing adequate ventilation on all sides. • Do not operate more than one unit side by side. • Replace cabinet fan. • Replace or reconnect temperature probe.
<i>Compressor runs with 3-beep intermittent low pressure alarm and low oxygen concentration.</i>	<ul style="list-style-type: none"> • Leak • Reduced air intake • Weak compressor • Faulty circuit board. 	<ul style="list-style-type: none"> • Leak test and repair leak. • Check compressor intake path for obstruction. Clean/remove obstruction. • Replace compressor. • Replace circuit board.
<i>Compressor does not start. I/O power switch in “I” position, intermittent 3-beep low pressure alarm, and cabinet fan turns.</i>	<ul style="list-style-type: none"> • Extreme cold start. • Faulty electrical connection for compressor. • Faulty capacitor. • Faulty circuit board. 	<ul style="list-style-type: none"> • Allow unit to reach room temperature. • Check electrical connections for compressor. • Replace capacitor. • Replace circuit board
<i>4-beep high pressure alarm is activated and both compressor and valves do not operate.</i>	<ul style="list-style-type: none"> • Restriction in exhaust muffler. • Contaminated sieve beds. • Faulty solenoid valve. • Faulty circuit board. 	<ul style="list-style-type: none"> • Replace exhaust muffler. • Replace sieve beds. • Replace solenoid valve manifold. • Replace circuit board.

Problem	Probable Cause	Solution
<i>Compressor relief valve activates (popping sound)</i>	<ul style="list-style-type: none"> • Faulty electrical connection at waste valve. • Faulty solenoid valve coil. (Acceptable rating: 713-837 Ohms) • Contaminated sieve beds. • Faulty circuit board. • Faulty relief valve. 	<ul style="list-style-type: none"> • Repair electrical connection. • Replace valve coil. (Use of an ohmmeter can be helpful to easily determine faulty coil). • Replace sieve beds. • Replace circuit board. • Replace relief valve.
<i>Unit alarms with I/O power switch in “I” position. Circuit breaker repeatedly trips.</i>	<ul style="list-style-type: none"> • Faulty electrical connection. • Faulty capacitor. • Faulty circuit breaker. • Faulty compressor. • Faulty circuit board. 	<ul style="list-style-type: none"> • Repair electrical connection. • Replace capacitor. • Replace circuit breaker. • Replace compressor. • Replace circuit board.
<i>Cabinet fan does not turn.</i>	<ul style="list-style-type: none"> • Faulty electrical connections. • Faulty cabinet fan. 	<ul style="list-style-type: none"> • Check electrical connections. • Replace cabinet fan.
<i>Flowmeter fluctuates</i>	<ul style="list-style-type: none"> • Improperly set or faulty product regulator. • Leak. • Reduced air intake (suction) • Faulty flowmeter. • Worn compressor. • Faulty circuit board. • Faulty solenoid valve. 	<ul style="list-style-type: none"> • Check regulator setting. Repair or replace regulator. • Leak test and repair leak. • Check compressor intake path for obstruction. Remove obstruction. • Replace flowmeter. • Replace compressor • Replace circuit board. • Replace solenoid valve manifold.
<i>Limited or low flow.</i>	<ul style="list-style-type: none"> • Restriction in humidifier/tubing. • Product regulator set too low. • Leak. • Reduced air intake (suction) • Weak compressor • Faulty circuit board • Restriction in mixing tank • Faulty solenoid valve. 	<ul style="list-style-type: none"> • Replace humidifier or tubing. • Adjust regulator setting. • Leak test and repair. • Check compressor intake path for obstruction and remove, if needed. • Check system pressure, and rebuild or exchange compressor. • Replace circuit board. • Replace mixing tank • Replace valve manifold.
<i>No flow indicated on flow meter, and 6-beep no flow alarm does not activate.</i>	<ul style="list-style-type: none"> • Internal leak. (likely in location from unit regulator to flow meter) • Main circuit boards prior to Rev. R do not have a ‘no flow’ alarm 	<ul style="list-style-type: none"> • Leak test and repair. In particular, regulator / fittings following air path to flow meter. Repair leaks.

Problem	Probable Cause	Solution
<i>Low oxygen concentration.</i>	<ul style="list-style-type: none"> • Ambient or unit's temperature is too high. • Leak. • Reduced air intake (suction) • Restriction in exhaust muffler • Contaminated sieve beds • Weak compressor. • Faulty circuit board. • Faulty solenoid valve 	<ul style="list-style-type: none"> • Unit operating above temperature range specifications. • Leak test and repair. • Blocked air intake or exhaust. • Defective cabinet fan. • Check compressor intake path for obstruction. Clean/remove obstruction. • Replace or clean exhaust muffler. • Replace sieve beds. • Check system pressure, and rebuild or replace compressor. • Replace circuit board • Replace valve manifold.
<i>No flow indicated on flowmeter, and 6-beep no flow alarm is activated.</i>	<ul style="list-style-type: none"> • Flowmeter is turned off. • Regulator is turned off. • Cannula tubing blocked or kinked • External restriction at outlet of unit • Internal restriction of airflow. 	<ul style="list-style-type: none"> • Turn flowmeter knob counterclockwise to allow flow of oxygen. • Unlock regulator knob and turn clockwise to allow flow of oxygen. (Refer to section 4.8 Product Regulator • Check and Setting for proper adjustment). • Check cannula tubing. Replace if necessary. • Reduce/remove attachments from outlet of unit (humidifier bottle, tubing, etc). • Check internal tubing for blockage or kinks.
<i>Alarm does not sound.</i>	<ul style="list-style-type: none"> • Unit has been turned off for an extended period of time. • Faulty electrical connection. • Faulty buzzer. • Faulty I/O power switch. • Faulty circuit board. 	<ul style="list-style-type: none"> • Turn on unit and let run for several minutes to charge alarm capacitor. With unit running, disconnect from power source and verify power failure alarm (1-beep). • Repair electrical connection • Replace buzzer. • Replace I/O power switch. • Replace circuit board.

5.4 Tool Kit and Pressure Test Gauge

The tools needed for you to properly service the VisionAire unit are listed below:

Multi-adjustable pliers, small wire cutters, small needle-nose pliers, slotted-head screwdriver, Phillips-head screwdriver, adjustable wrench, 1/2-inch combination wrench, 7/16-inch combination wrench, 9/16-inch combination wrench, and 1/8-inch Allen wrench.

Pressure test adapter. (AirSep p/n: KI257-2).

A pressure test gauge (AirSep p/n: KI036-1) to read operating system pressures on the VisionAire unit should be kept available at all times.

An ohmmeter/multi-meter is a useful diagnostic tool when troubleshooting electrical components (coil, etc).

Appendix

Exploded Drawings

Wiring Diagram - VisionAire	A
Wiring Diagram – VisionAire 2, VisionAire 3	B
Valve Wire Harness – WH105-1	C
Main Assembly	D
Center Section Assembly	E
Compressor Enclosure Assembly	F
Compressor Assembly	G
Valve Manifold Assembly	H

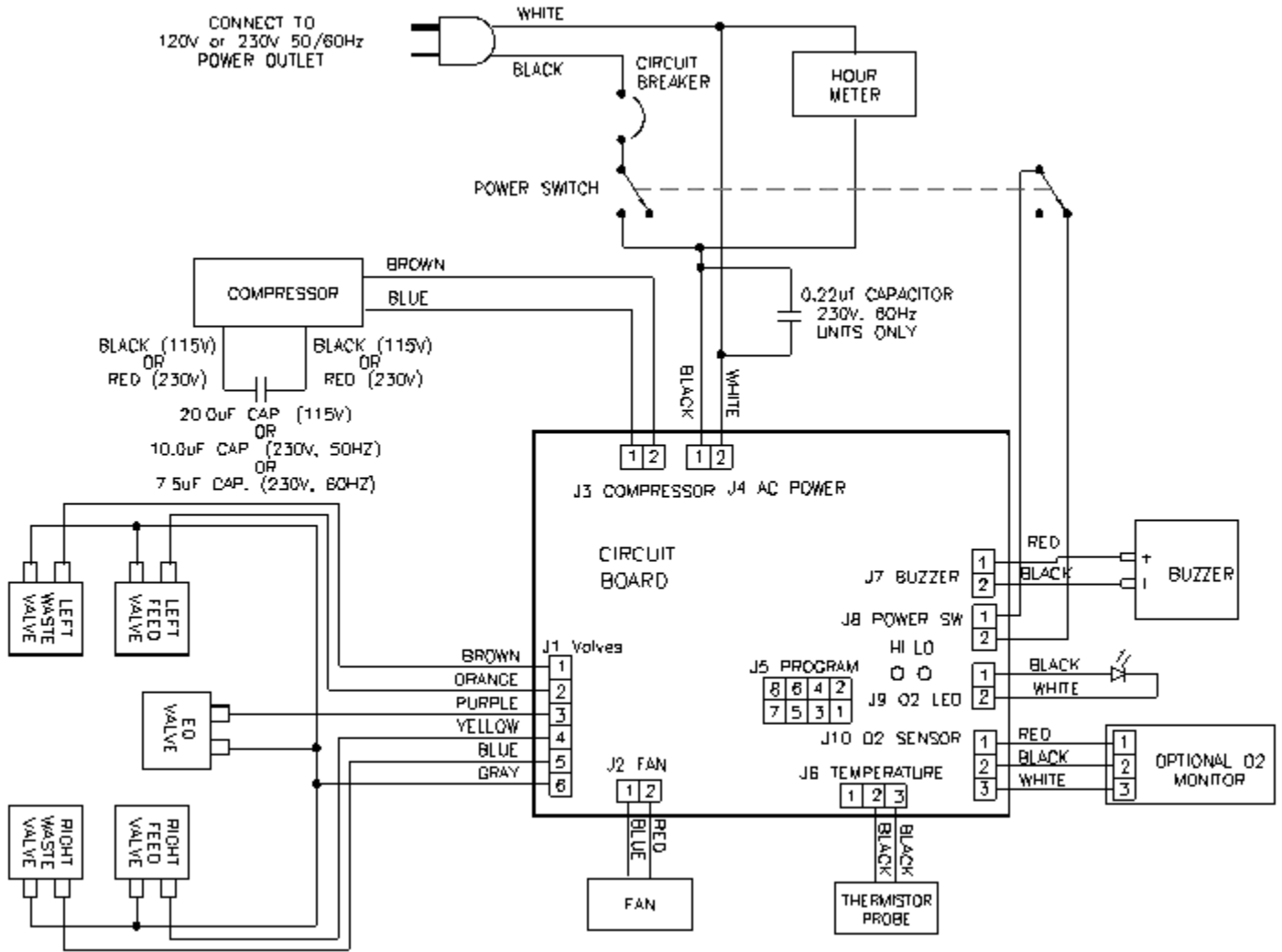

**WIRING DIAGRAM
VISIONAIRE 115V AND 230V**

A

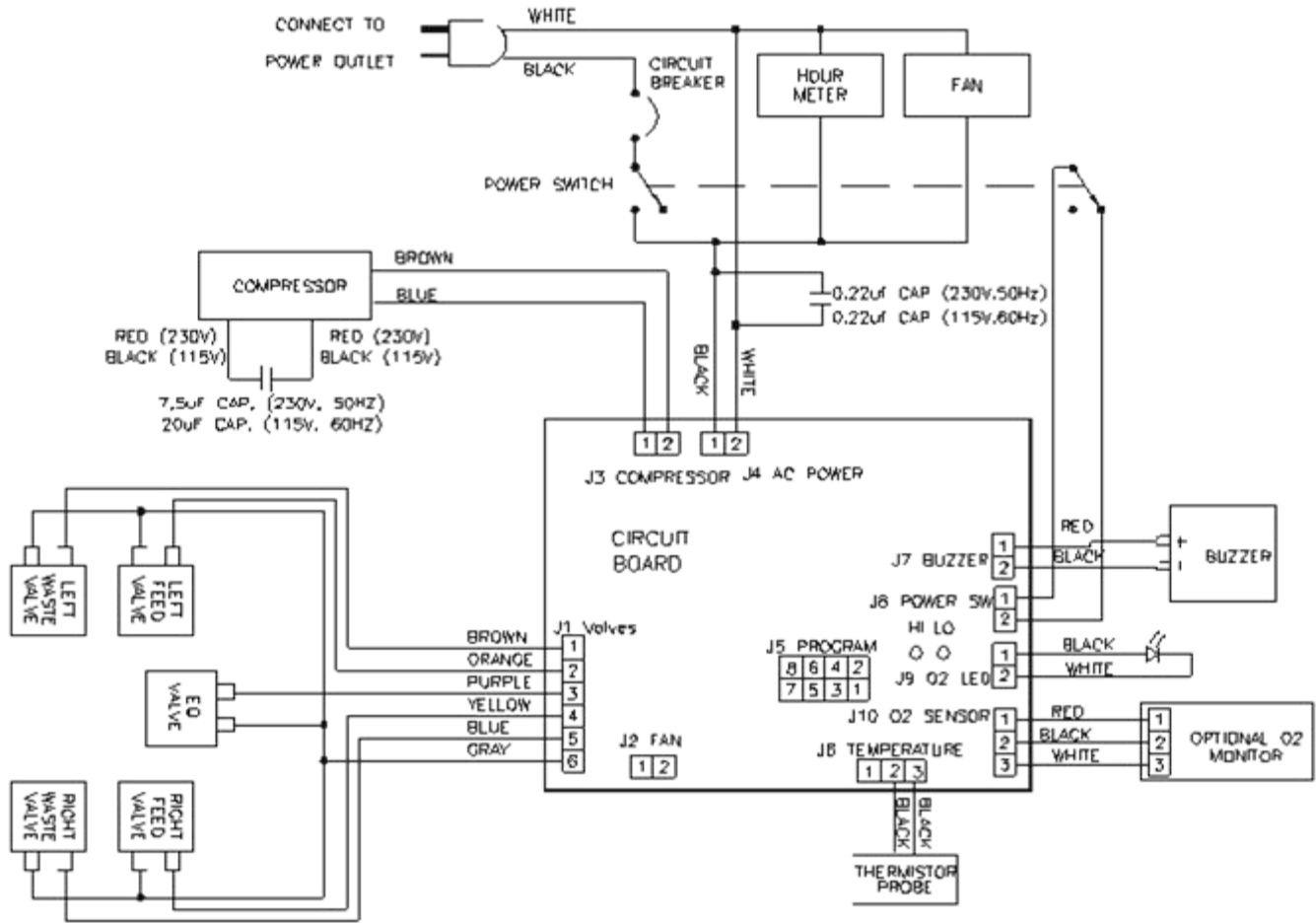

**WIRING DIAGRAM
VISIONAIRE 2, VISIONAIRE 3**

B

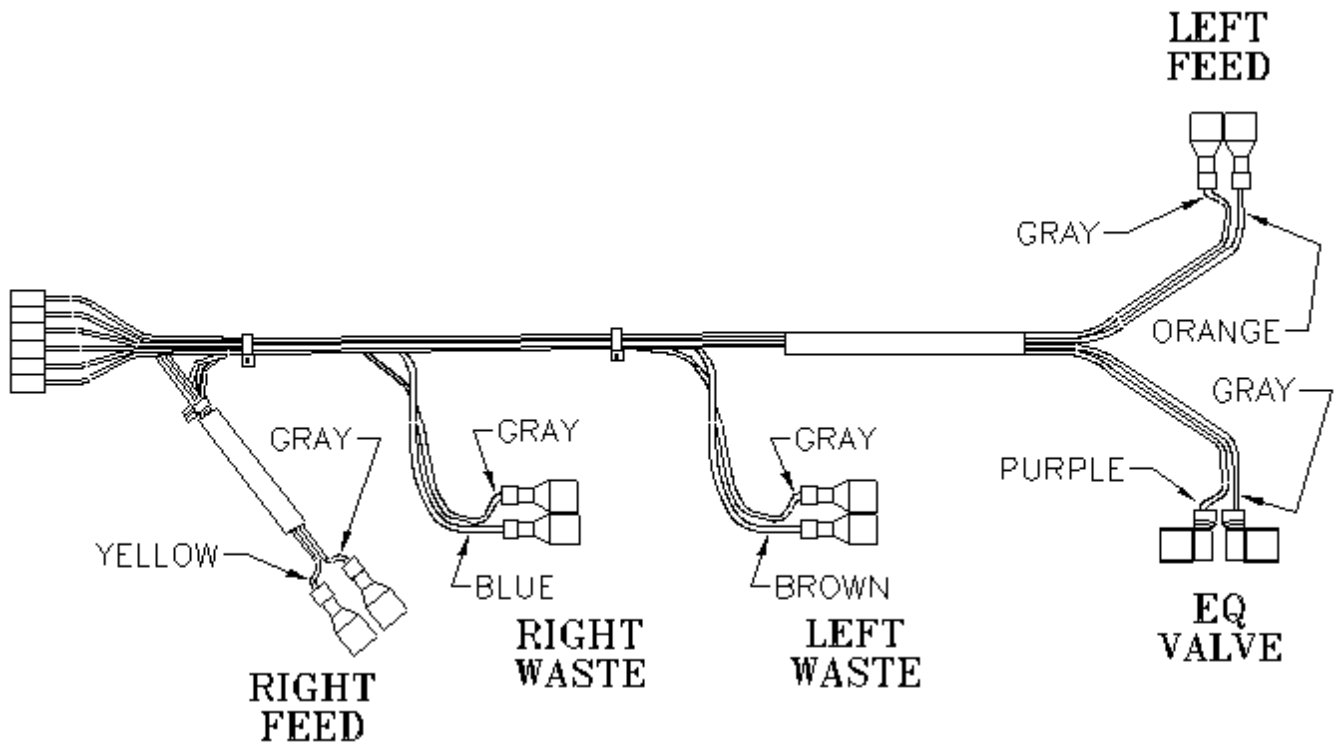

VALVE WIRE HARNESS

C

ITEM	PART NUMBER	DESCRIPTION
1	CA262-1	CABINET, MOUNTING PLATE, SWITCH
2	CA263-1	CABINET, MOUNTING PLATE, FLOWMETER
3	CA265-2	CABINET, BACK PANEL ASSY
4	CA268-1	CABINET, ROLLER BASE (ONLY)
5	CA271-1	CABINET, COMPRESSOR COVER
6	CA283-1	CABINET, CENTER SECTION
7	CA280-1	CABINET, FRONT PANEL ASSY
8	CA280-2	CABINET, FRONT PANEL ASSY, W/O2 MONITOR
9	CA285-1	CABINET, FRONT PANEL ASSY (VISIONAIRE 3)
10	CA285-2	CABINET, FRONT PANEL ASSY, W/ O2 MONITOR (VISIONAIRE 3)
11	CA285-3	CABINET, FRONT PANEL ASSY, W/ O2 MONITOR (VISIONAIRE 2)
12	CR001-5	CIRCUIT BREAKER, 220-240V
13	CR001-6	CIRCUIT BREAKER, 115V
14	CS001-1	CASTER

ITEM	PART NUMBER	DESCRIPTION
15	F0724-1	FITTING, AIR OUTLET
16	FA038-1	FASTENER, RUBBER KEEPER
17	FM033-2	FLOWMETER, 1/4 FITTING
18	FM067-1	FLOWMETER, 1/8 FITTING
19	FM070-1	FLOWMETER, 2 LPM
20	FM073-1	FLOWMETER, (VISIONAIRE 3)
21	HM009-2	HOUR METER
22	LA360-1	LABEL, AIR OUTLET
23	MI268-1	HUMIDIFIER STRAP
24	SC111-1	SCREW, 1/4 TURN
25	SC112-1	SCREW, RETAINER, 1/4 TURN
26	SW114-1	SWITCH, ON-OFF
27	WA055-1	WASHER, INTERNAL LOCK, TOOTH

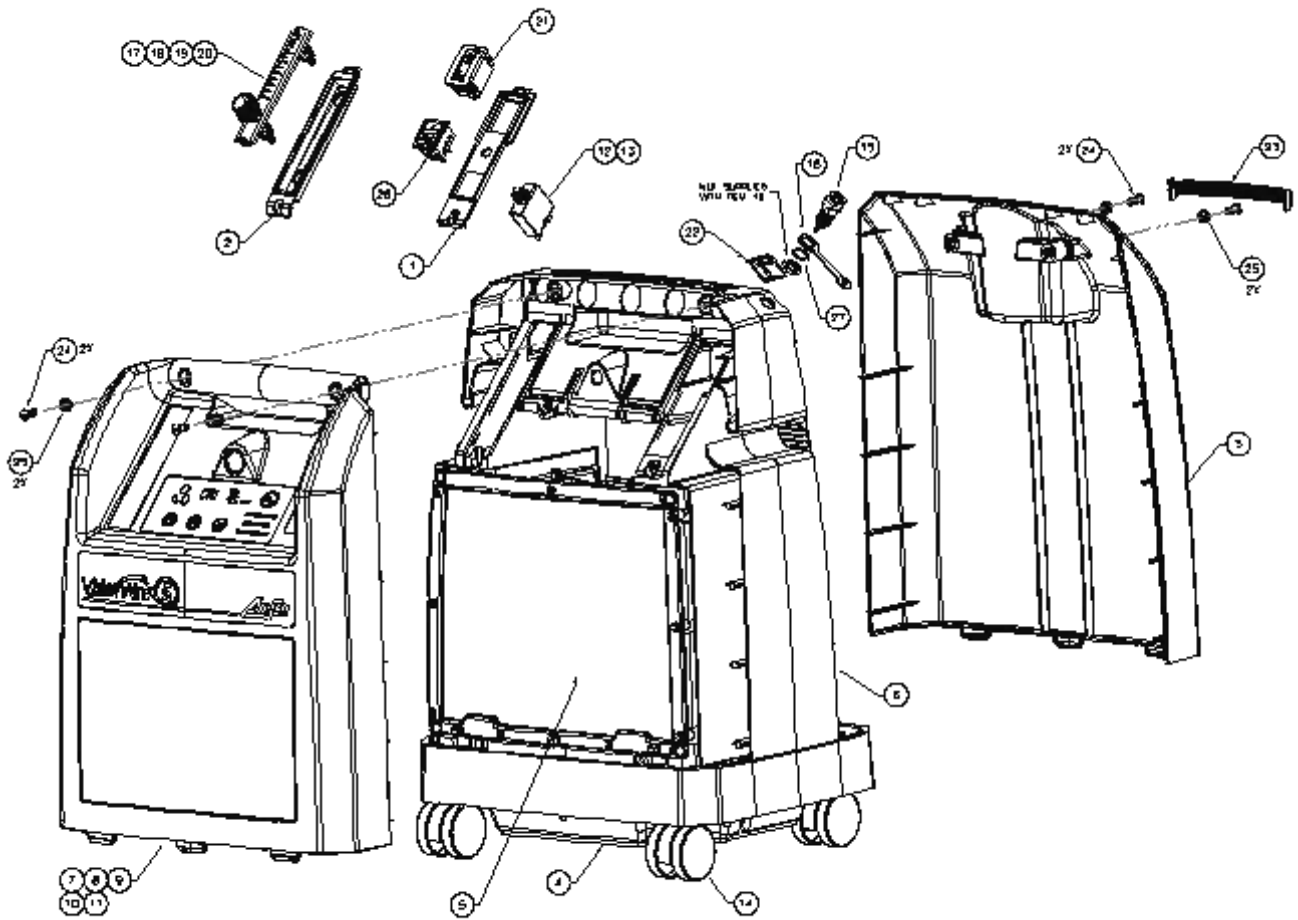

MAIN ASSEMBLY

D

ITEM	PART NUMBER	DESCRIPTION
1	BE187-2	BEDS, ASSY, SI018-1 (VISIONAIRE, VISIONAIRE 3)
2	BE187-4	BEDS, ASSY, SI015-1 (VISIONAIRE 2)
3	CA261-1	CABINET, HANDLE, PLATE
4	CA283-1	CABINET, CENTER SECTION
5	CB114-1	CIRCUIT BOARD, OXYGEN MONITOR
6	FO149-1	FOAM, HANDLE, PLATE
7	RG096-1	REGULATOR

ITEM	PART NUMBER	DESCRIPTION
8	SC037-4	SCREW, SELFTAP, CABINET HANDLE
9	SC084-1	SCREW, SELFTAP, REGULATOR
10	SC119-1	SCREW, OXYGEN MONITOR
11	TA004-1	TANK, ASSY, VOLUME (VISIONAIRE 2 ONLY)
12	TA121-1	TANK, MIXING (VISIONAIRE, VISIONAIRE 3)
13	TW002-1	TIE WRAP, SIEVE BED
14	TW017-1	TIE WRAP, HEAT STABILIZED

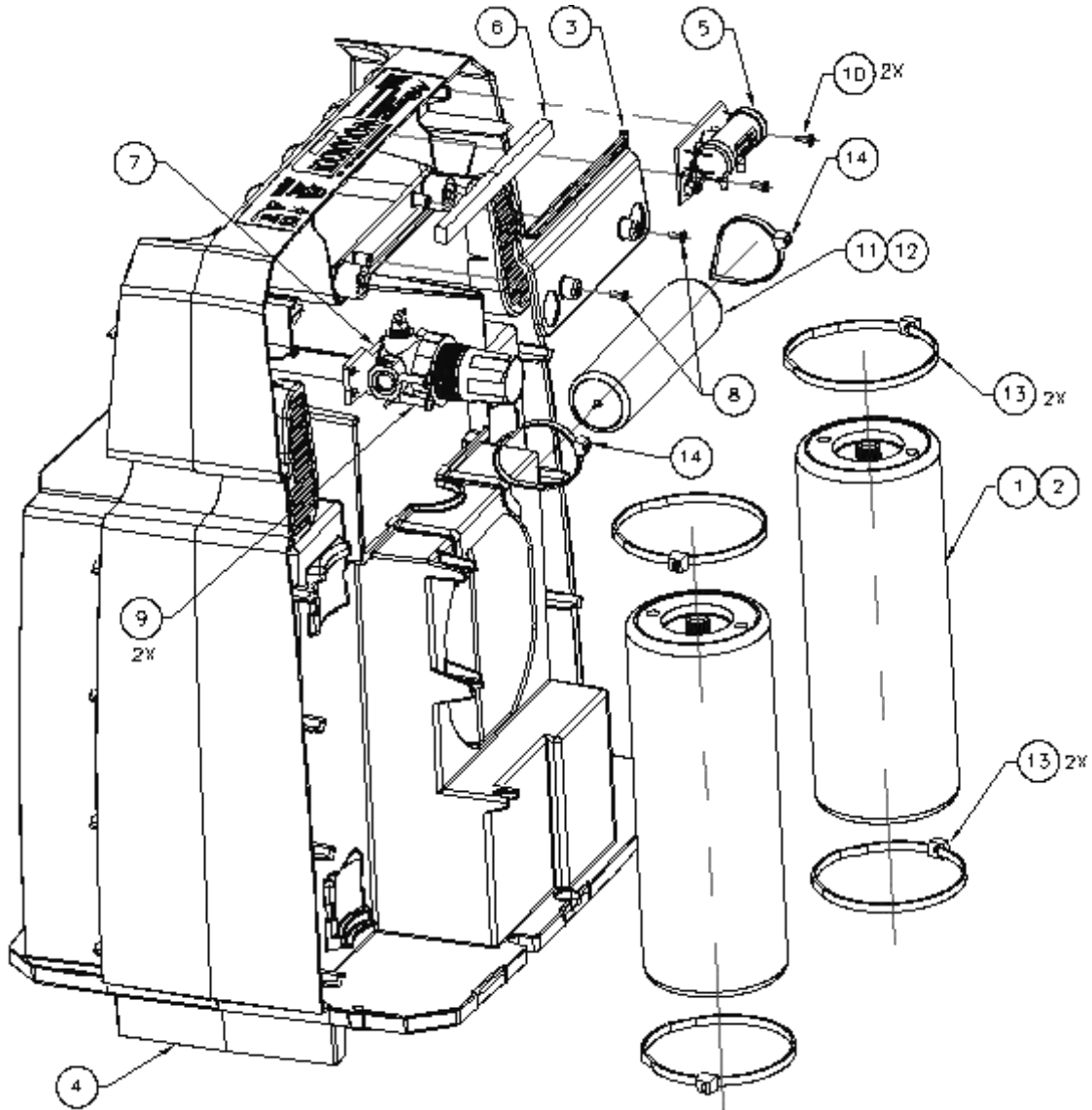

CENTER SECTION ASSEMBLY

E

ITEM	PART NUMBER	DESCRIPTION
1	AL018-1	ALARM, BUZZER
2	CA284-1	CABINET, COMPRESSOR, ENCLOSURE
3	CB102-1	CIRCUIT BOARD, MAIN
4	CB102-3	CIRCUIT BOARD, MAIN (V2, V3)
5	CC006-6	CAPACITOR, 220-240V
6	CC006-8	CAPACITOR, 120V
7	CC006-10	CAPACITOR, 230V
8	F0005-3	FITTING, MUFFLER
9	FN019-1	FAN, 115V (V2, V3)
10	FN041-1	FAN, 115V, VISIONAIRE
11	FN046-1	FAN, 230V, VISIONAIRE
12	FN047-1	FAN, 230V (V2, V3)

ITEM	PART NUMBER	DESCRIPTION
13	FO146-1	FOAM, FAN MOUNT
14	MO025-1	MOUNT, COMPRESSOR
15	MU043-1	MUFFLER, EXHAUST, TOP HALF
16	MU083-1	MUFFLER, CHAMBER
17	SC003-3	SCREW, SELFTAP, COMPRESSOR MOUNT
18	SC037-4	SCREW, SELFTAP, ALARM/CB
19	TW001-3	TIE WRAP, 4"
20	TW017-1	TIE WRAP, HEAT STAB
21	TU165-104	TUBING, BRAIDED SILICONE
22	TU180-064	TUBING, EXHAUST
23		COMPRESSOR, ASSY
24		VALVE, BLOCK, ASSY

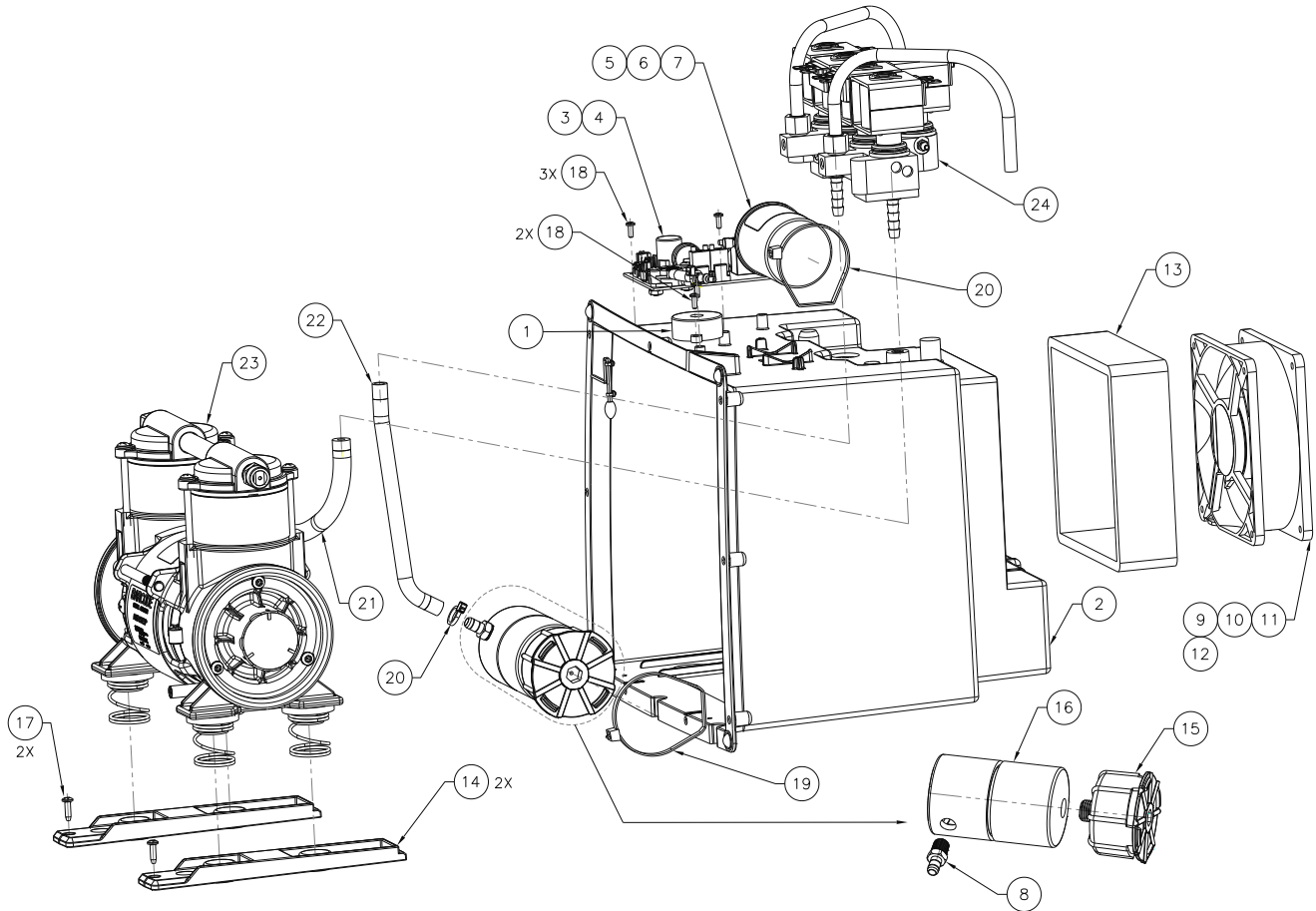

COMPRESSOR ENCLOSURE ASSEMBLY

F

ITEM	PART NUMBER	DESCRIPTION
1	CL035-1	CLAMP, WIRE
2	CO416-1	COMPRESSOR, 115V, 60Hz, 36 STROKE
3	CO416-2	COMPRESSOR, 230V, 50Hz, 44 STROKE
4	CO416-3	COMPRESSOR, 230V, 60Hz, 36 STROKE
5	CO416-5	COMPRESSOR, 230V, 50Hz, 26 STROKE, (VISIONAIRE 2,3)
6	CO416-6	COMPRESSOR, 115V, 60Hz, 26 STROKE, (VISIONAIRE 2, 3)
7	CO432-1	COMPRESSOR, END CAP ASSY
8	F0644-1	FITTING, BRASS, ELBOW
9	F1196-1	FILTER, COMPRESSOR END CAP, EXTERIOR, ASC

ITEM	PART NUMBER	DESCRIPTION
10	MO027-1	MOUNT, RUBBER SPRING
11	OR032-1	O-RING
12	SC123-3	SCREW, END CAP
13	SC133-1	SCREW, COMPRESSOR
14	SC133-2	SCREW, SPRING MOUNT
15	SP021-1	SPRING
16	WA059-1	WASHER, SPRING MOUNT
17	VA554-1	VALVE, RELIEF

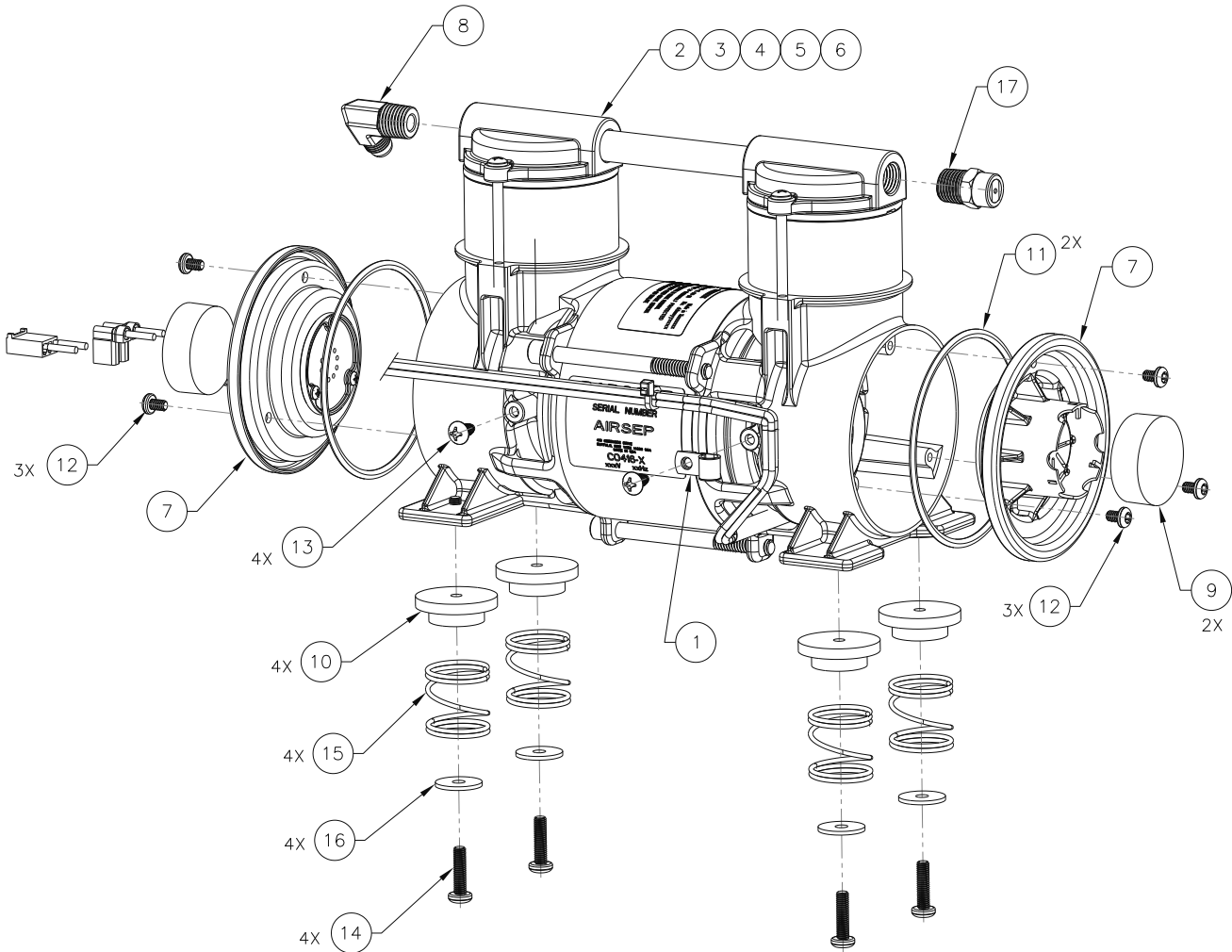

COMPRESSOR ASSEMBLY

G

ITEM	PART NUMBER	DESCRIPTION
1	F0037-4	FITTING, BRASS, MULTIBARB, FEED / WASTE
2	F0134-1	FITTING, COMPRESSION, 5/16"
3	F0494-1	FITTING, BRASS
4	F0517-1	FITTING, BRASS, EQ
5	F0645-1	FITTING, SWIVEL HOSE BARB
6	FO147-1	FOAM, FEED, FITTING
7	FO148-1	FOAM, EXHAUST, FITTING
8	HA064-1	HARDWARE, COIL, ECLIP
9	MA198-1	MANIFOLD, VALVE BLOCK

ITEM	PART NUMBER	DESCRIPTION
10	OR022-1	O-RING, MOUNTING BOLT
11	SC118-1	SCREW, MOUNTING BOLT
12	TU165-104	TUBING, BRAIDED SILICONE
13	TU152-070	TUBING, PRESSURE PORT
14	TU180-064	TUBING, EXHAUST
15	TW001-4	TIE WRAP, 4"
16	TW016-1	TIE WRAP, 4.88" LG
17	TW011-2	TIE WRAP, 2.83" LG
18	VA374-1	VALVE, COIL

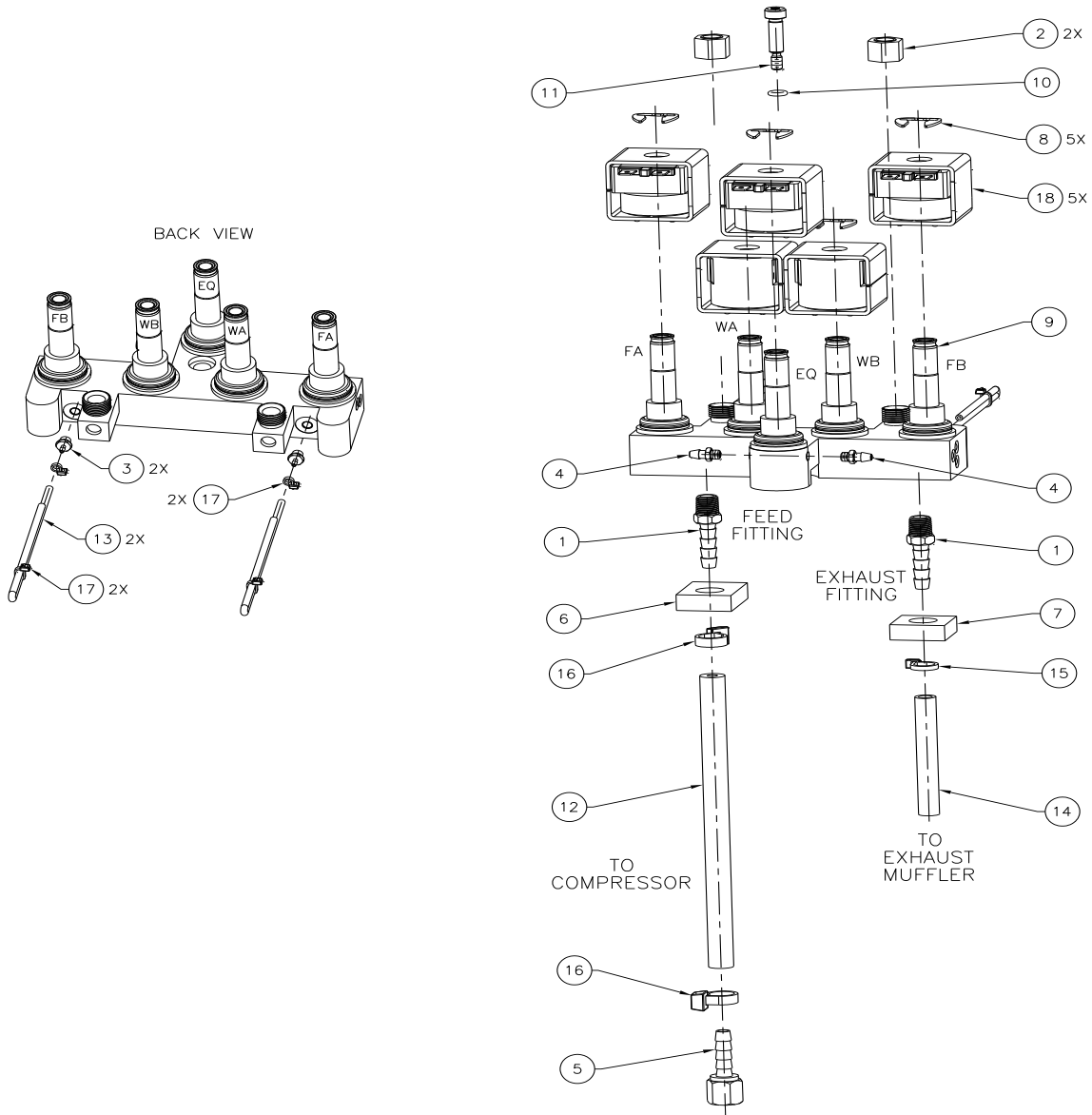

VALVE MANIFOLD ASSEMBLY

H